

Mainboard SYNC installation Guide

CAUTION

Please power off the PC and check the Positive and Negative ends on the connector before connecting the cable to mainboard. Connecting the wrong end can damage the LEDs.

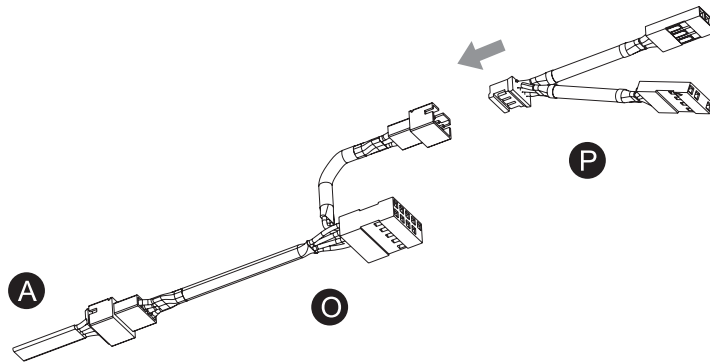
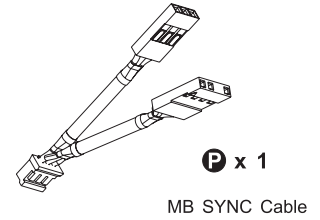
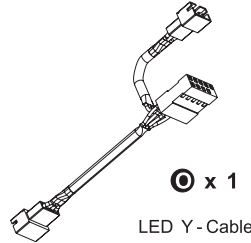

Connect the MB SYNC Cable to Water block

ASUS

Aura Addressable Strip Header(s)

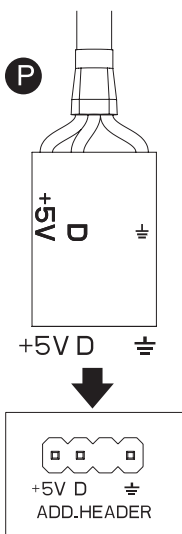

MSI

JRGB-strip Header(S)

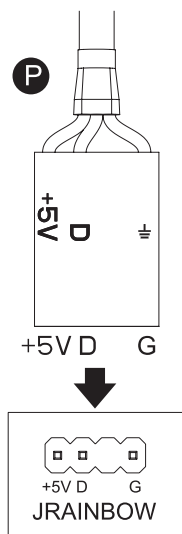

ASROCK

Addressable RGB LED Header(s)

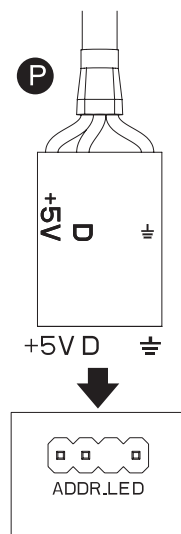

GIGABYTE

AORUS RGB Fusion with Digital LEDs

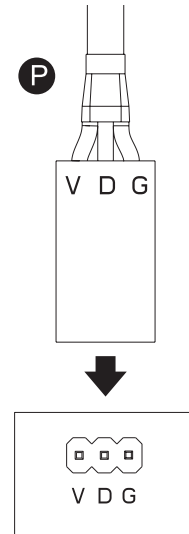

TT RGB Plus Software control interface

Please download software from Thermaltake Official website.

www.thermaltake.com/home.aspx

and search "TT RGB Plus" on the official website.

OS compatibility: Windows 7 / 8 / 8.1 / 10

When you open the software, choose the "VGA Plus" in the drop-down list(C-3) first.

1. Software User Interface

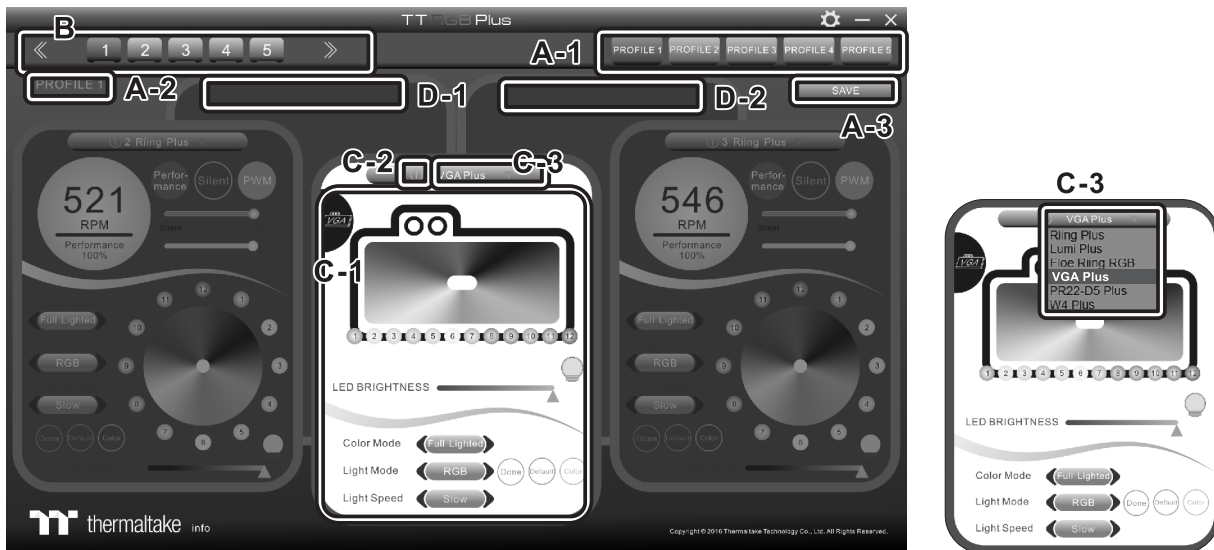

A. TT RGB Plus software Profile Setting

A-1 Set up a profile: Choose a Profile and set up the LED Lighting Mode, then click the SAVE icon(A-3) to store your settings to the software.

A-2 Save a profile to controller: Select a profile and a controller, then click the Save icon to assign the profile to the controller.

B. Follow the Installation Guide step 3, you can set up the number of the controller

C. LED Lighting Mode

Full Lighted / Wave / Pulse / Ripple / Blink / Sound Control / RGB Spectrum / Flow / Thermal...

C-1 LED Selection: set up the LEDs lighting, color, and speed .

Light Mode: Choose a lighting mode

Color Mode: Choose the LEDs color

Light Speed: Set up the speed of the LEDs light

LED Spot & Color Palette: Choose the color of each of the individual LEDs by clicking the color palette

Done: Save your setting

Default: Reset the LED setting back to the default

Brightness: Drag the mouse to adjust LED light brightness.

LED On/Off: Click the LED Light icon to turn on or off the LED light

RGB Color Code: Enter the Decimal Code of Red, Green, and Blue to set the LEDs color

C-2 LED On/Off: User can switch off the LED control function in the software if the fan is not plug into the controller.

C-3 Drop-down list: click the product name to choice another you want.

D-1 & D-2. Product Selection: click the control panel to rotate it to the front

2. Mobile APP Connection Password

To connect the Riing Plus RGB APP, please connect the PC to your wireless first, and click the Password setting under the software setting menu, set up your connection password. The TT RGB Plus APP will ask for your password every time when starting the APP.

For more information please visit www.thermaltake.com

